

## 1/8 Solenoid Operated Directional Valves, DSG-01 Series

These are Solenoid Operated Directional Valves of high pressure, high flow and low pressure drop, the features of which can be materialized by employing a powerful wet type solenoid and the rational flow channel design.

### High Pressure & High Flow Rate

In comparison to our existing lines, both the pressure and flow of these valves are much increased.

- Max. Operating Pressure: approx. 10 % increased [31.5→35 MPa (4570 →5080 PSI)]
- Max. T-Line Back Pressure: approx. 30 % increased [16→21 MPa (2320 →3050 PSI)]
- Max. Flow Rate: approx. 60 % increased [63→100 L/min (16.64 →26.42 U.S.GPM)]

### Low Pressure Drop

The pressure drop of these valves is reduced by 10 % from 1.0 to 0.9 MPa (145 to 131 PSI), in comparison to our existing lines\*; the valves effectively reduce the energy consumption of the unit.

{\* At Flow Rate: 60 L/min (15.9 U.S.GPM), Spool Type: 3C2 (P→A)}

### Compact & Small Mass

Despite of high pressure, high flow and low pressure drop, these valve bodies are compact and lightweight with DC double solenoids; the overall length and mass are reduced from 210 to 205 mm (8.26 to 8.07 inch) and from 2.2 to 1.85 kg (4.85 to 4.08 lbs), respectively.

### Shockless type available

In addition to the standard valves for high pressure and high flow, a shockless type capable of minimizing noise and vibration in piping during spool changeover is also available.

### Stable Operation

Due to the powerful magnetic and spring force of the solenoids, these valves exhibit a high tolerance to contaminants and especially stable operation.

### IP65-equivalent high dust- and water-proof

These valves demonstrate excellent dust- and water-proof characteristics, in compliance with I. E. C. Pub. 529. IP65 and JIS C 0920 IP65 (dust- and jet-proof type).

### Usable in products of various standards

These standard valves are CE certified for installation in equipment overseas. UL/CSA certified products are also available.

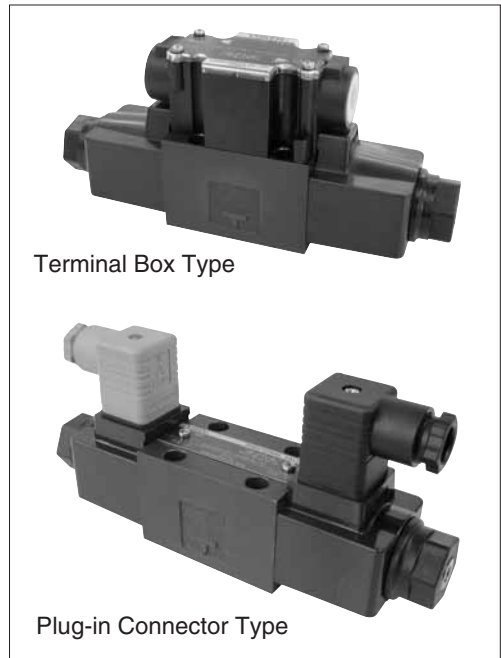

Terminal Box Type

Plug-in Connector Type

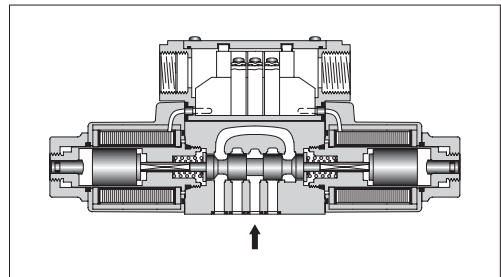

## Specifications

Valve Type	Model Numbers	Max. Flow <sup>★2</sup> L/min (U.S.GPM)	Max. Operating Pressure MPa (PSI)	Max. T-Line Back Pressure MPa (PSI)	Max. Changeover Frequency Cycle/min {min <sup>-1</sup> }	Mass kg (lbs.)
Standard Type	DSG-01-3C*-70/7090	100 (26.4)	35 (5080)	21 (3050)	300 (R Type Sol. Only) 120	1.85 (4.08)
	DSG-01-2D2*-70/7090					1.4(3.09)
	DSG-01-2B*-70/7090					1.85(4.08)
Shockless Type	S-DSG-01-3C*-70/7090	63 (16.6)	25 (3630)	21 (3050)	120	1.4(3.09)
	S-DSG-01-2B2*-70/7090					1.85(4.08)
Low Wattage(14W) Type <sup>★1</sup>	L-DSG-01-3C*-70/7090	40 (10.6)	16 (2320)	16 (2320)	300 (R Type Sol. Only) 120	1.85 (4.08)
	L-DSG-01-2D2*-70/7090					1.4(3.09)
	L-DSG-01-2N*-70/7090					1.85(4.08)
	L-DSG-01-2B***-70/7090					1.4(3.09)

★ 1. For details of L-DSG-01, please contact us.

★ 2. Maximum flow indicates a ceiling flow depends on the type of spool and operating condition, refer to the List of Spool Functions on pages 347 to 351 for details.

## Sub-plate

Piping Size	Japanese Standard "JIS "		European Design Standard		N.American Design Standard		Approx. Mass kg (lbs.)
	Sub-plate Model Numbers	Thread Size	Sub-plate Model Numbers	Thread Size	Sub-plate Model Numbers	Thread Size	
1/8	DSGM-01-31	Rc 1/8	DSGM-01-3180	1/8 BSP.F	DSGM-01-3190	1/8 NPT	0.8 (1.8)
1/4	DSGM-01X-31	Rc 1/4	DSGM-01X-3180	1/4 BSP.F	DSGM-01X-3190	1/4 NPT	0.8 (1.8)
3/8	DSGM-01Y-31	Rc 3/8	—	—	DSGM-01Y-3190	3/8 NPT	0.8 (1.8)

- Sub-plates are available. Specify the sub-plate model number from the table above. When sub-plates are not used, the mounting surface should have a good machined finish.

## Mounting Bolt

For socket head cap screws in the table below are included.

Descriptions	Soc. Hd. Cap Screw (4 pcs.)	Tightening Torque
Japanese Standard "JIS" European Design Standard	M5 × 45 Lg.	5 - 7 Nm (43 - 60 in. lbs.) Applicable to working pressure more than 25 MPa (3630 PSI): 6 - 7 Nm (52 - 60 in. lbs.)
N. American Design Standard	No. 10-24 UNC × 1-3/4 Lg.	

## Solenoid Ratings

Valve Type	Electric source	Coil Type	Frequency (Hz)	Voltage (V)		Current & Power at Rated Voltage				
				Source Rating	Serviceable Range	Inrush (A) <sup>*2</sup>	Holding (A)	Power (W)		
Standard Type	AC <sup>*1</sup>	A100	50	100	80 - 110	2.42	0.51	—		
				100	90 - 120	2.14	0.37			
			60	110	—	2.35	0.44			
				120	96 - 132	2.02	0.42			
			60		108 - 144	1.78	0.31			
				A200	50	200	160 - 220		1.21	0.25
		200	180 - 240			1.07	0.19			
		60	220		—	1.18	0.22			
			240		192 - 264	1.01	0.21			
		60			216 - 288	0.89	0.15			
			Shockless Type		DC (K Series)	—	D12		10.8 - 13.2	—
		D24		21.6 - 26.4			—		1.23	
D48	43.2 - 52.8	—		0.61						
AC → DC Rectified (R)	50/60	R100		90 - 110	—	0.33	29			
		R200		180 - 220	—	0.16				
				—	—	—		—		

- ★1. AC solenoid is not available in shockless type. R type models with built-in current rectifier is recommended for shockless operation with AC power.
- ★2. Inrush current in the above table show rms values at maximum stroke.
- ★3. There are more coil types other than the above. For details, please make inquiries.

The coil type numbers in the shaded column are handled as optional extras. In case these coils are required to be chosen, please confirm the time of delivery with us before ordering.

## Options

### Push Button with Lock Nut

Can be used for manual changeover of spool. The push button can be locked in the pressed condition.

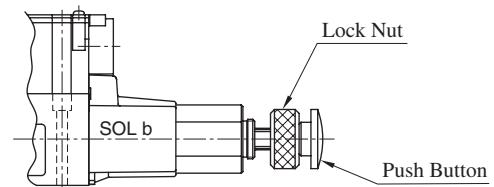

### Plug-in Connector with Solenoid Indicator Light

These are the indicator light incorporated plug-in connector type solenoids. Energisation or de-energisation of the solenoid can be easily identified with the incorporated indicator light.

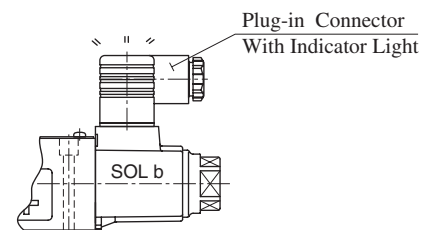

■ Model Number Designation











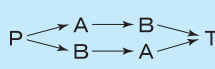
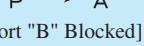
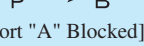

F-	S-	DSG	-01	-2	B	2	A	-D24	-C	-N	-70	*	-L
Special Seals	Shockless Type	Series Number	Valve Size	Number of Valve Positions	Spool-Spring Arrangement	Spool Type	Special Two Position Valve (Omit if not required)	Coil Type	Manual Override	Electrical Conduit Connection	Design Number	Design Standard	Models with Reverse Mtg. of Solenoid (Omit if not required)
<b>F:</b> For Phosphate Ester Type Fluids (Omit if not required)	<b>None:</b> Standard Type	<b>DSG:</b> Solenoid Operated Directional Valve	<b>01</b>	<b>3:</b> Three Positions	<b>C:</b> Spring Centred	2, 3 4, 40 60, 9 10, 11 12	—	AC: <b>A100</b> <b>A120</b> <b>A200</b> <b>A240</b>	<b>None:</b> Manual Override Pin	<b>None:</b> Terminal Box Type	<b>70</b>	<b>None:</b> Japanese Std. "JIS"  <b>90:</b> N.American Design Std.	—
				<b>2:</b> Two Positions	<b>D:</b> No-Spring Detented	2	—	DC: <b>D12</b> <b>D24</b> <b>D48</b>					<b>C:</b> Push Button and Lock Nut (Option)
	<b>3:</b> Three Positions			<b>C:</b> Spring Centred	2 4	—	DC: <b>D12</b> <b>D24</b> <b>D48</b>	R: (AC→DC) <b>R100</b> <b>R200</b>	<b>N1:</b> <sup>*2</sup> Plug-in Connector Type with Indicator Light (Option)	<b>90:</b> N. American Design Std.		—	
	<b>2:</b> Two Positions			<b>B:</b> Spring Offset	2	—	R: (AC→DC) <b>R100</b> <b>R200</b>					L	

★1. In case of the special two position valve, please refer to page 352 for details.  
 ★2. N1 is not available for R type solenoids.

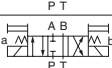
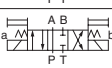
In the table above, the symbols or numbers highlighted with shade represent the optional extras. The valves with model number having such optional extras are handles as options, therefore, please confirm the time of delivery with us before ordering.

■ List of Standard Models and The Maximum Flow

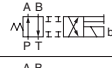
● Models with AC Solenoids: DSG-01-\*\*\*-A\*

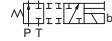
No. of Valve Positions	Spool-Spring Arrangement	Model Numbers	Graphic Symbols	Max. Flow L/min														
																		
				Working Pressure MPa					Working Pressure MPa					Working Pressure MPa				
				10	16	25	31.5	35	10	16	25	31.5	35	10	16	25	31.5	35
Three Positions	Spring Centred	DSG-01-3C2		100	100	100	100	100	100(43) 57(38)	100(41) 53(31)	80(21) 29(17)	60(17) 19(10)	38(15) 13(9)	100(43) 57(38)	100(41) 53(31)	80(21) 29(17)	60(17) 19(10)	38(15) 13(9)
		DSG-01-3C3		100(80) 90(63)	100(80) 90(63)	100(80) 90(63)	100(77) 90(63)	100(77) 90(63)	70(46) 45(30)	70(46) 45(30)	70(46) 45(30)	70(46) 45(30)	70(46) 45(30)	70(46) 45(30)	70(46) 45(30)	70(46) 45(30)	70(46) 45(30)	70(46) 45(30)
		DSG-01-3C4		90	90	90	90(22) 43(14)	35(18) 30(11)	100(38) 50(31)	76(28) 38(20)	67(15) 20(10)	57(10) 16(7)	35(7) 12(5)	100(38) 50(31)	76(28) 38(20)	67(15) 20(10)	57(10) 16(7)	35(7) 12(5)
		DSG-01-3C40		85	85	85	80(40) 63(15)	80(22) 25(10)	85(40) 70(26)	85(35) 50(24)	85(24) 32(16)	60(16) 22(13)	55(12) 18(10)	85(40) 70(26)	85(35) 50(24)	85(24) 32(16)	60(16) 22(13)	55(12) 18(10)
		DSG-01-3C60★		43(23) 40(23)	43(23) 40(23)	42(23) 38(23)	42(23) 36(23)	42(23) 35(23)	54(32) 48(30)	54(32) 47(30)	52(32) 47(30)	52(32) 47(30)	52(32) 47(30)	54(32) 48(30)	54(32) 47(30)	52(32) 47(30)	52(32) 47(30)	52(32) 47(30)
		DSG-01-3C9		100	100	100	100	100	20	15	10	10	8	20	15	10	10	8
		DSG-01-3C10◆		100	100	100(63) 80(20)	100(33) 70(20)	100(27) 40(19)	100(50) 100(37)	100(37) 55(25)	100(20) 29(14)	78(16) 20(11)	62(13) 15(10)	100(50) 100(37)	100(37) 55(25)	100(20) 29(14)	78(16) 20(11)	62(13) 15(10)
		DSG-01-3C11◆		100	100	100	100	100	23	20	13	10	5	100(65) 70(50)	85(52) 57(40)	72(45) 50(25)	65(34) 43(19)	60(27) 35(18)
		DSG-01-3C12◆		100	100	100(63) 80(20)	100(33) 70(20)	100(27) 40(19)	100(50) 100(37)	100(37) 55(25)	100(20) 29(14)	78(16) 20(11)	62(13) 15(10)	100(50) 100(37)	100(37) 55(25)	100(20) 29(14)	78(16) 20(11)	62(13) 15(10)
		Two Positions	No-Spring Detented	DSG-01-2D2		80	80	80	80	80	45	45	45(21) 36(18)	45(16) 28(13)	38(13) 22(12)	50	50(45) 50(45)	50(42) 50(42)
DSG-01-2B2				85	85	85	85	85	20	16	16	15	13	85(63) 85(30)	80(50) 60(33)	63(40) 50(28)	44(32) 40(28)	44(32) 40(28)
Spring Offset	DSG-01-2B3			70	70	70	70	70	50	50	50	50	50	80(70) 70(48)	80(70) 70(48)	80(70) 70(48)	80(70) 70(48)	80(70) 70(48)
	DSG-01-2B8			—	—	—	—	—	26	17	13	11	10	80(50) 35(20)	70(40) 23(15)	60(20) 15(8)	45(10) 10(5)	30(10) 7(5)

Notes: 1. The relation between the maximum flow in the table above and the frequency/voltage (within the serviceable voltage) is as shown below.

( Example )

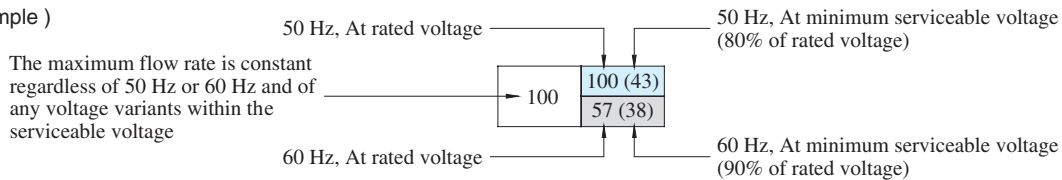











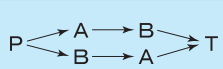
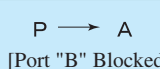
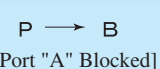
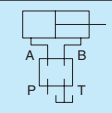
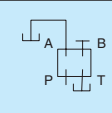
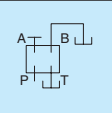

2. For the maximum flow rate in P → T of the valves with a ★ mark, please see page 351.

The valve models with a ◆ mark are handled as Options. If you choose such valves, check the time of delivery beforehand.

DSG-01 Series Solenoid Operated Directional Valves

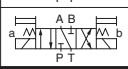
■ List of Standard Models and The Maximum Flow

● Models with DC or R Type Solenoids: DSG-01-\*\*\*-D\*/R\*

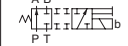
No. of Valve Positions	Spool-Spring Arrangement	Model Numbers	Graphic Symbols	Max. Flow L/mi														
									 [Port "B" Blocked]					 [Port "A" Blocked]				
																		
				Working Pressure MPa					Working Pressure MPa					Working Pressure MPa				
				10	16	25	31.5	35	10	16	25	31.5	35	10	16	25	31.5	35
Three Positions	Spring Centred	DSG-01-3C2		100	100	100	100	100	100	45	28	25	22	100	45	28	25	22
		DSG-01-3C3		100	100	100	100	100	78	78	78	78	75	78	78	78	78	75
		DSG-01-3C4		90	90	90	50	38	100	58	38	31	29	100	58	38	31	29
		DSG-01-3C40		85	85	65	40	33	85	52	30	26	24	85	52	30	26	24
		DSG-01-3C60		50	50	50	50	50	66	66	66	66	66	66	66	66	66	66
		DSG-01-3C9		100	100	100	100	100	20	15	10	10	8	20	15	10	10	8
		DSG-01-3C10		85	85	85	80	40	100	56	36	28	24	100	56	36	28	24
		DSG-01-3C11		100	100	100	100	100	23	20	13	10	5	100	60	40	36	32
		DSG-01-3C12		85	85	85	80	40	100	56	36	28	24	100	56	36	28	24
Two Positions	No-Spring Detented	DSG-01-2D2		75	75	75	75	75	45	45	40	30	27	50	50	45	45	
		70	70	70	70	70	30	25	22	45	42	40	40					
	Spring Offset	DSG-01-2B2		80	80	80	80	80	20	16	16	15	13	46	31	24	22	22
		DSG-01-2B3		70	70	70	70	70	50	50	50	50	50	75	75	75	75	75
		DSG-01-2B8		—	—	—	—	—	26	17	13	11	10	53	35	23	19	17
35	30	17	13	12														

Notes: 1. The relation between the maximum flow in the table above and the voltage (within the serviceable voltage) is as shown below.

( Example )

The maximum flow rate is constant regardless of any voltage variants within the serviceable voltage

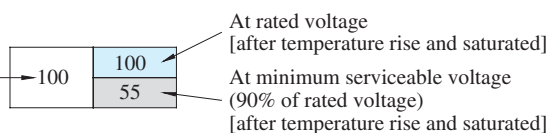









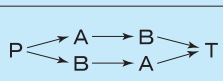
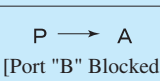
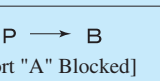



2. For the maximum flow rate in P → T of the valves with a ★ mark, please see page 351.

The valve models with a ◆ mark are handled as Options. If you choose suce valves, check the time of delivery beforehand.

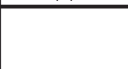
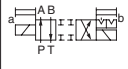
■ List of Standard Models and The Maximum Flow

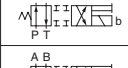
● Models with AC Solenoids: DSG-01-\*\*\*-A\*

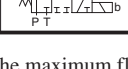
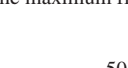
No. of Valve Positions	Spool-Spring Arrangement	Model Numbers	Graphic Symbols	Max. Flow U.S.GPM														
																		
				Working Pressure PSI					Working Pressure PSI					Working Pressure PSI				
				1450	2320	3630	4570	5080	1450	2320	3630	4570	5080	1450	2320	3630	4570	5080
Three Positions	Spring Centred	DSG-01-3C2		26.4	26.4	26.4	26.4	26.4	26.4(11.4)	26.4(10.8)	21.1(5.6)	15.9(4.5)	10.0(4.0)	26.4(11.4)	26.4(10.8)	21.1(5.6)	15.9(4.5)	10.0(4.0)
		DSG-01-3C3		26.4(21.1)	26.4(21.1)	26.4(21.1)	26.4(21.1)	26.4(21.1)	18.5(12.2)	18.5(12.2)	18.5(12.2)	18.5(12.2)	18.5(12.2)	18.5(12.2)	18.5(12.2)	18.5(12.2)	18.5(12.2)	18.5(12.2)
		DSG-01-3C4		23.8	23.8	23.8	23.8(5.8)	9.2(4.8)	23.8(6.9)	11.4(3.7)	7.9(2.9)	13.2(8.2)	10.0(5.3)	5.3(2.6)	4.2(1.9)	3.2(1.3)	13.2(8.2)	10.0(5.3)
		DSG-01-3C40		22.5	22.5	22.5	21.1(10.6)	21.1(5.8)	22.5(10.6)	22.5(9.3)	22.5(6.3)	15.9(4.2)	14.5(3.2)	22.5(10.6)	22.5(9.3)	22.5(6.3)	15.9(4.2)	14.5(3.2)
		DSG-01-3C60		11.4(6.1)	11.4(6.1)	11.1(6.1)	11.1(6.1)	11.1(6.1)	14.2(8.4)	14.2(8.4)	13.7(8.4)	13.7(8.4)	13.7(8.4)	14.2(8.4)	14.2(8.4)	13.7(8.4)	13.7(8.4)	13.7(8.4)
		DSG-01-3C9		26.4	26.4	26.4	26.4	26.4	5.3	4.0	2.6	2.6	2.1	5.3	4.0	2.6	2.6	2.1
		DSG-01-3C10		26.4	26.4	26.4(16.6)	26.4(8.7)	26.4(7.1)	26.4(13.2)	26.4(9.8)	26.4(5.3)	20.6(4.2)	16.4(3.4)	26.4(13.2)	26.4(9.8)	26.4(5.3)	20.6(4.2)	16.4(3.4)
		DSG-01-3C11		26.4	26.4	26.4	26.4	26.4	6.1	5.3	3.4	2.6	1.3	26.4(17.2)	22.5(13.7)	19.0(13.7)	17.2(9.0)	15.9(7.1)
		DSG-01-3C12		26.4	26.4	26.4(16.6)	26.4(8.7)	26.4(7.1)	26.4(13.2)	26.4(9.8)	26.4(5.3)	20.6(4.2)	16.4(3.4)	26.4(13.2)	26.4(9.8)	26.4(5.3)	20.6(4.2)	16.4(3.4)
		Two Positions	No-Spring Detented	DSG-01-2D2		21.1	21.1	21.1	21.1	21.1	11.9	11.9	11.9(5.6)	11.9(4.2)	10.0(3.4)	13.2	13.2(11.9)	13.2(11.1)
DSG-01-2B2				22.5	22.5	22.5	22.5	22.5	5.3	4.2	4.2	4.0	3.4	22.5(16.6)	21.1(13.2)	16.6(10.6)	11.6(8.5)	11.6(8.5)
Spring Offset	DSG-01-2B3			18.5	18.5	18.5	18.5	18.5	13.2	13.2	13.2	13.2	13.2	21.1(18.5)	21.1(18.5)	21.1(18.5)	21.1(18.5)	21.1(18.5)
	DSG-01-2B8			—	—	—	—	—	6.9	4.5	3.4	2.9	2.6	21.1(13.2)	18.5(10.6)	15.9(5.3)	11.9(2.6)	7.9(2.6)
	DSG-01-2B2			22.5	22.5	22.5	22.5	22.5	5.3	4.2	4.2	4.0	3.4	22.5(16.6)	21.1(13.2)	16.6(10.6)	11.6(8.5)	11.6(8.5)
	DSG-01-2B3			18.5	18.5	18.5	18.5	18.5	13.2	13.2	13.2	13.2	13.2	21.1(18.5)	21.1(18.5)	21.1(18.5)	21.1(18.5)	21.1(18.5)

Notes: 1. The relation between the maximum flow in the table above and the frequency/voltage (within the serviceable voltage) is as shown below.

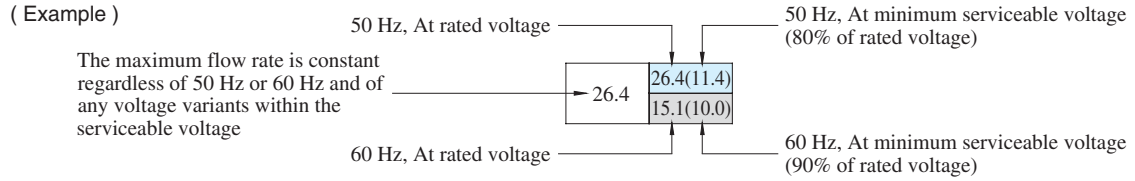

2. For the maximum flow rate in P → T of the valves with a ★ mark, please see page 351.

The valve models with a ◆ mark are handled as Options. If you choose such valves, check the time of delivery beforehand.

DSG-01 Series Solenoid Operated Directional Valves

■ List of Standard Models and The Maximum Flow

● Models with DC or R Type Solenoids: DSG-01-\*\*\*-D\*/R\*

No. of Valve Positions	Spool-Spring Arrangement	Model Numbers	Graphic Symbols	Max. Flow U.S.GPM														
				Working Pressure PSI					Working Pressure PSI					Working Pressure PSI				
				1450	2320	3630	4570	5080	1450	2320	3630	4570	5080	1450	2320	3630	4570	5080
				1450	2320	3630	4570	5080	1450	2320	3630	4570	5080	1450	2320	3630	4570	5080
Three Positions	Spring Centred	DSG-01-3C2		26.4	26.4	26.4	26.4	26.4	26.4	11.9	7.4	6.6	5.8	26.4	11.9	7.4	6.6	5.8
		DSG-01-3C3		26.4	26.4	26.4	26.4	26.4	20.6	20.6	20.6	20.6	19.8	20.6	20.6	20.6	20.6	19.8
		DSG-01-3C4		23.8	23.8	23.8	13.2	10.0	26.4	15.3	10.0	8.2	7.7	26.4	15.3	10.0	8.2	7.7
		DSG-01-3C40		22.5	22.5	17.2	10.6	8.7	22.5	13.7	7.9	6.9	6.3	22.5	13.7	7.9	6.9	6.3
		DSG-01-3C60		13.3	13.3	13.3	13.3	13.3	17.4	17.4	17.4	17.4	17.4	17.4	17.4	17.4	17.4	17.4
		DSG-01-3C9		26.4	26.4	26.4	26.4	26.4	5.3	4.0	2.6	2.6	2.1	5.3	4.0	2.6	2.6	2.1
		DSG-01-3C10		22.5	22.5	22.5	21.1	10.6	26.4	14.8	9.5	7.4	6.3	26.4	14.8	9.5	7.4	6.3
		DSG-01-3C11		26.4	26.4	26.4	26.4	26.4	6.1	5.3	3.4	2.6	1.3	26.4	15.9	10.6	9.5	8.5
		DSG-01-3C12		22.5	22.5	22.5	21.1	10.6	26.4	14.8	9.5	7.4	6.3	26.4	14.8	9.5	7.4	6.3
		Two Positions	No-Spring Detented	DSG-01-2D2		19.8	19.8	19.8	19.8	19.8	11.9	11.9	10.6	7.9	7.1	13.2	13.2	11.9
18.5	18.5			18.5	18.5	18.5	7.9	6.6	5.8	13.2	11.1	10.6	10.6					
Spring Offset	DSG-01-2B2			21.1	21.1	21.1	21.1	21.1	5.3	4.2	4.2	4.0	3.4	12.2	8.2	6.3	5.8	5.8
	DSG-01-2B3			18.5	18.5	18.5	18.5	18.5	13.2	13.2	13.2	13.2	13.2	19.8	19.8	19.8	19.8	19.8
	DSG-01-2B8			—	—	—	—	—	6.9	4.5	3.4	2.9	2.6	14.0	9.2	6.1	5.0	4.5
	9.3		7.9	4.5	3.4	3.2												

Notes: 1. The relation between the maximum flow in the table above and the voltage (within the serviceable voltage) is as shown below.

( Example )

The maximum flow rate is constant regardless of any voltage variants within the serviceable voltage

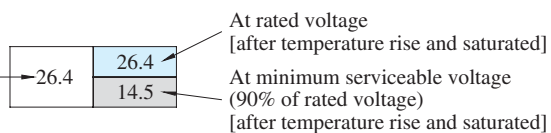

2. For the maximum flow rate in P → T of the valves with a ★ mark, please see page 351.

The valve models with a ◆ mark are handled as Options. If you choose suce valves, check the time of delivery beforehand.

## Maximum Flow of Centre By-Pass

In valve type 3C60, in case where the actuator is put on in between the cylinder ports A and B as illustrated below and where the actuator moves and suspended at its stroke end and where the valve is then shifted to the neutral position in the suspended state of the actuator, the maximum flow rates available are those as shown as the table below regardless of any voltage in the range of serviceable voltage.

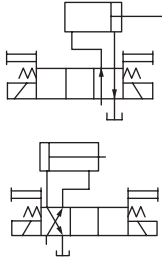

Mode Numbers	Graphic Symbol	Max. Flow L/min (U.S.GPM)				
		10 MPa (1450 PSI)	16 MPa (2320 PSI)	25 MPa (3630 PSI)	31.5 MPa (4570 PSI)	35 MPa (5080 PSI)
DSG-01-3C60-A*/D*/R*		55 (14.5)	44 (11.6)	30 (7.9)	26 (6.9)	22 (5.8)

## List of Shockless Models and The Maximum Flow

- Models with DC or R Type Solenoids: S-DSG-01-\*\*\*-D\*/R\*

No. of Valve Positions	Spool-Spring Arrangement	Model Numbers	Graphic Symbol	Max. Flow L/min (U.S.GPM)								
				Working Pressure MPa (PSI)			Working Pressure MPa (PSI)			Working Pressure MPa (PSI)		
				10 (1450)	16 (2320)	25 (3630)	10 (1450)	16 (2320)	25 (3630)	10 (1450)	16 (2320)	25 (3630)
Three Positions	Spring Centred	S-DSG-01-3C2		63 (16.6)	63 (16.6)	40 (10.6)	40 (10.6)	32 (8.5)	25 (6.6)	40 (10.6)	32 (8.5)	25 (6.6)
		S-DSG-01-3C4		60 (15.9)	50 (13.2)	40 (10.6)	40 (10.6)	32 (8.5)	16 (4.2)	40 (10.6)	32 (8.5)	16 (4.2)
Two Positions	Spring Offset	S-DSG-01-3B2		50 (13.2)	45 (11.9)	45 (11.9)	30 (7.9)	30 (7.9)	30 (7.9)	60 (15.9)	40 (10.6)	40 (10.6)
				45 (11.9)	40 (10.6)	40 (10.6)						

Notes: 1. The relation between the maximum flow in the table above and the voltage (within the serviceable voltage) is as shown below.

( Example )

The maximum flow rate is constant regardless of any voltage variants within the serviceable voltage

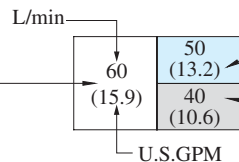

At rated voltage [after temperature rise and saturated]  
 At minimum serviceable voltage (90% of rated voltage) [after temperature rise and saturated]

DSG-01 Series Solenoid Operated Directional Valves



■ Reverse Mounting of Solenoid.

In spring offset type, it is a standard configuration that the solenoid is mounted onto the valve in the SOL b position (side). However, in this particular spool-spring arrangement, the mounting of the solenoid onto the valve in the reverse position -SOL a side- is also available. The graphic symbol for this reverse mounting is as shown below. As for the valve type 2B\*A and 2B\*B, please refer to the explanation under the heading of "Valves Using Neutral Position and Side Position" given below.



■ Valves Using Neutral Position and Side Position. (Special Two position Valve)

Besides the use of the standard 2-position valves aforementioned in the "List of Standard Models and Maximum Flow", the 3-position valves also can be used as the 2-position valves using the two of their three positions. In this case, there are two kinds of the valve available. One is the valve using the neutral position and SOL a position (2B\*A) and another is the valve using the neutral position and SOL b position (2B\*B).

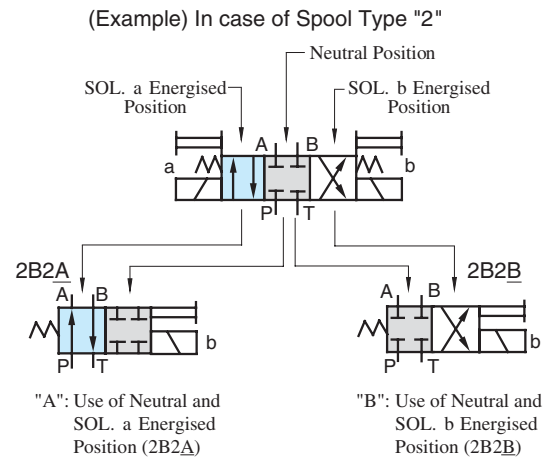

Model Numbers	Graphic SymbolsG	
	Standard Mtg. Type	Reverse Mtg. Type
DSG-01-2B*A		
DSG-01-2B2A		—

Model Numbers	raphic Symbols	
	Standard Mtg. Type	Reverse Mtg. Type
DSG-01-2B*B		
DSG-01-2B2B		—
DSG-01-2B3B		—
DSG-01-2B4B		
DSG-01-2B60B		—
DSG-01-2B10B		—

In the above table, the graphic symbols in mounting type highlighted with shade are optional extra, therefore, please confirm the time of delivery with us before ordering.

## ■ Typical Changeover Time

Changeover time varies according to oil viscosity, spool type and hydraulic circuit.

### ● Standard Type (Without Shockless Function)

#### [Test Conditions ]

Pressure: 16 MPa (2320 PSI)  
 Flow Rate: 31.5 L/min (8.3 U.S.GPM)  
 Viscosity: 35 mm<sup>2</sup>/s (164 SSU)  
 Voltage: 100 %V  
 (After coil temprature rises and saturated)

#### [Result of Measurement]

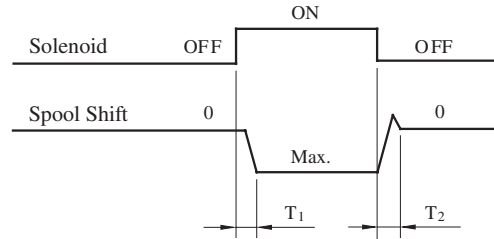

Type	Model Numbers	Time ms	
		T <sub>1</sub>	T <sub>2</sub>
Standard Type	DSG-01-3C2- A*	15	23
	DSG-01-3C2- D*	48	19
	DSG-01-3C2- R*	50	100

### ● Shockless Type

#### [Test Circuit and Conditions]

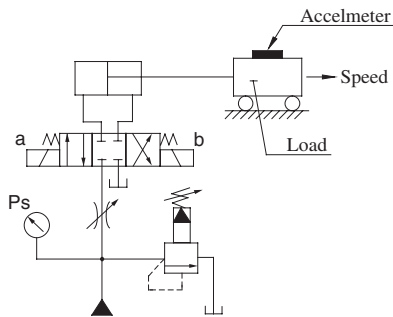

Setting Pressure (Ps): 7 MPa (1020 PSI)  
 Load (W): 1000 kg (2205 lbs.)  
 Speed: 8 m/min (26.2 ft./min)  
 Viscosity: 35 mm<sup>2</sup>/s (164 SSU)

#### [Results of Measurement]

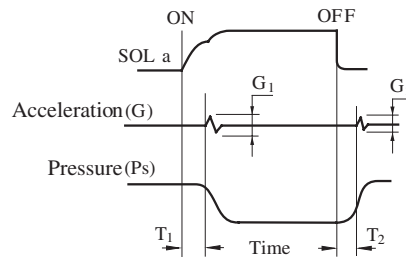

Type	Model Numbers	Time ms		Acceleration m/s <sup>2</sup> (G)	
		T <sub>1</sub>	T <sub>2</sub>	G <sub>1</sub>	G <sub>2</sub>
Shockless Type	S-DSG-01-3C2- D*	70	30	12 (1.2)	7 (0.7)
Standard Type	DSG-01-3C2- D*	35	25	18 (1.8)	15 (1.5)

**Pressure Drop**

Pressure drop curves based on viscosity of 35 mm<sup>2</sup>/s (164 SSU) and specific gravity of 0.850.

**Standard Type: DSG-01**

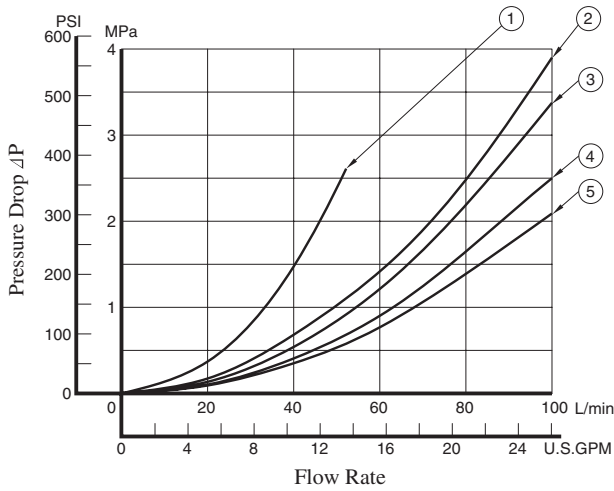

Model Numbers	Pressure Drop Curve Number				
	P→A	B→T	P→B	A→T	P→T
DSG-01-3C2	④	④	④	④	—
DSG-01-3C3	⑤	⑤	⑤	⑤	②
DSG-01-3C4	④	④	④	④	—
DSG-01-3C40	④	④	④	④	—
DSG-01-3C60	①	①	①	①	②
DSG-01-3C9	⑤	③	⑤	③	—
DSG-01-3C10	④	⑤	④	④	—
DSG-01-3C11	④	④	④	④	—
DSG-01-3C12	④	④	④	⑤	—
DSG-01-2D2	⑤	④	⑤	④	—
DSG-01-2B2	⑤	④	⑤	④	—
DSG-01-2B3	⑤	⑤	⑤	⑤	—
DSG-01-2B8	⑤	—	④	—	—

**Shockless Type: S-DSG-01**

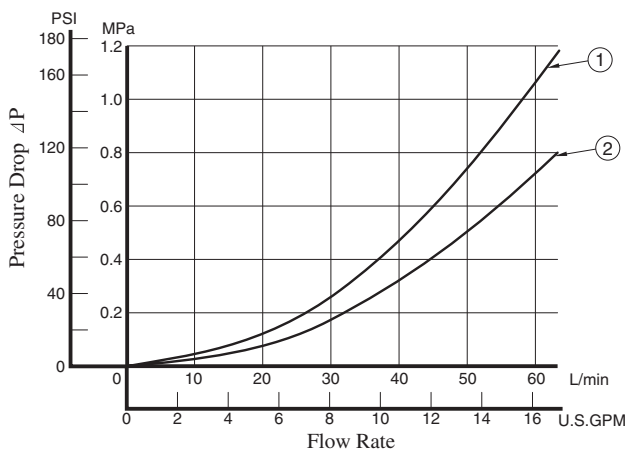

Model Numbers	Pressure Drop Curve Number			
	P→A	B→T	P→B	A→T
S-DSG-01-3C2	①	①	①	①
S-DSG-01-3C4	①	②	①	②
S-DSG-01-2B2	①	①	①	①

For any other viscosity, multiply the factors in the table below.

Viscosity	mm <sup>2</sup> /s	15	20	30	40	50	60	70	80	90	100
		SSU	77	98	141	186	232	278	324	371	417
Factor		0.81	0.87	0.96	1.03	1.09	1.14	1.19	1.23	1.27	1.30

For any other specific gravity (G'), the pressure drop (ΔP') may be obtained from the formula below.

$$\Delta P' = \Delta P (G'/0.850)$$

Mounting surface: ISO 4401-AB-03-4-A

## TERMINAL BOX TYPE

### Models with AC Solenoids

- Double Solenoid: Spring Centred & No-Spring Detented

DSG-01-<sup>3C\*</sup>/<sub>2D2</sub>-A\*-70/7090

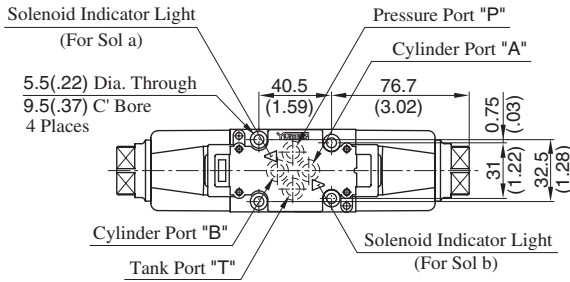

- Single Solenoid: Spring Offset  
DSG-01-2B\*-A\*-70/7090

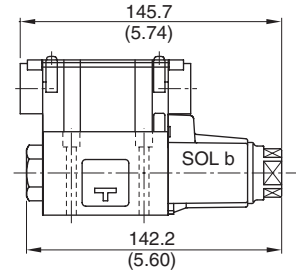

- For other dimensions, refer to "spring Centred and No-Spring Detented" models.
- Solenoid being mounted in the reverse position SOL a side is also available.

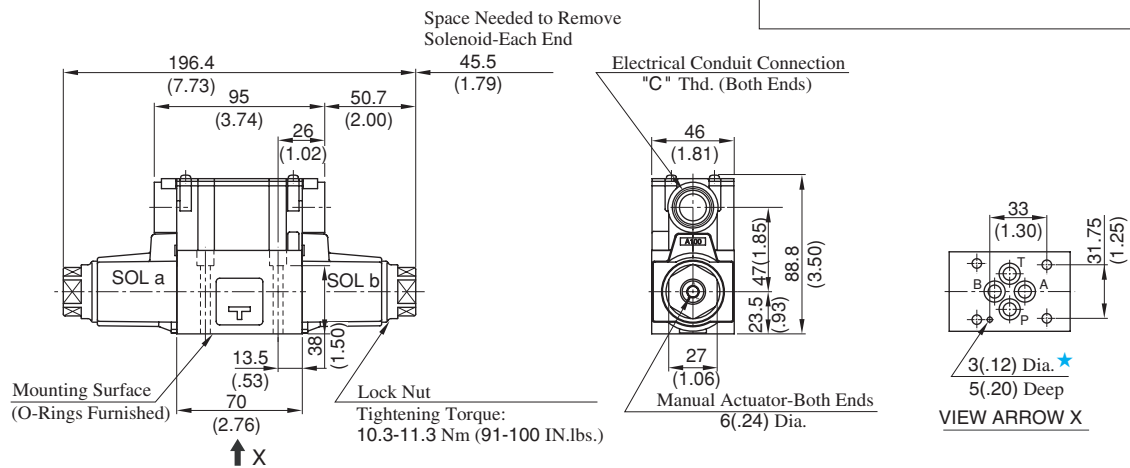

Model Numbers	"C" Thd.
DSG-01-***-A*-70	G 1/2
DSG-01-***-A*-7090	1/2 NPT

★ Locating pin can be fitted to this hole to conform with ISO4401-03-02-94. However, locating pin is not provided to standard design valve. When ordering valve with a locating pin, please consult Yuken.

**DIMENSIONS IN MILLIMETRES (INCHES)**

### Models with DC Solenoids: (S-)DSG-01-\*\*\*-D\*-70/7090

### Models with R Type Solenoids: (S-)DSG-01-\*\*\*-R\*-70/7090

- Spring Centred
- No-Spring Detented
- Spring Offset

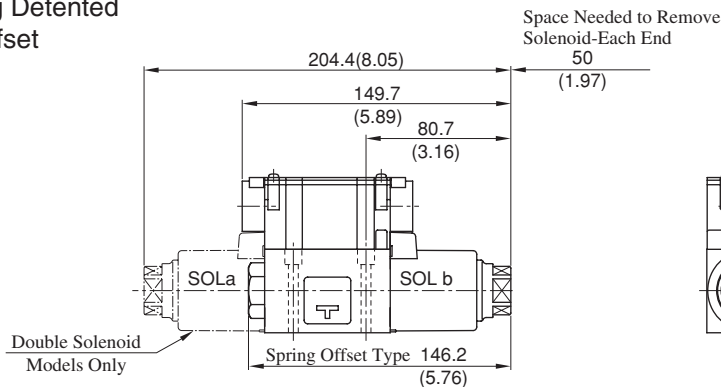

● For other dimensions, refer to models with AC solenoids.

E

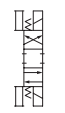

DSG-01 Series Solenoid Operated Directional Valves

■ Sub-plate : DSGM-01/01X/01Y-31/3180/3190

**DIMENSIONS IN  
MILLIMETRES (INCHES)**

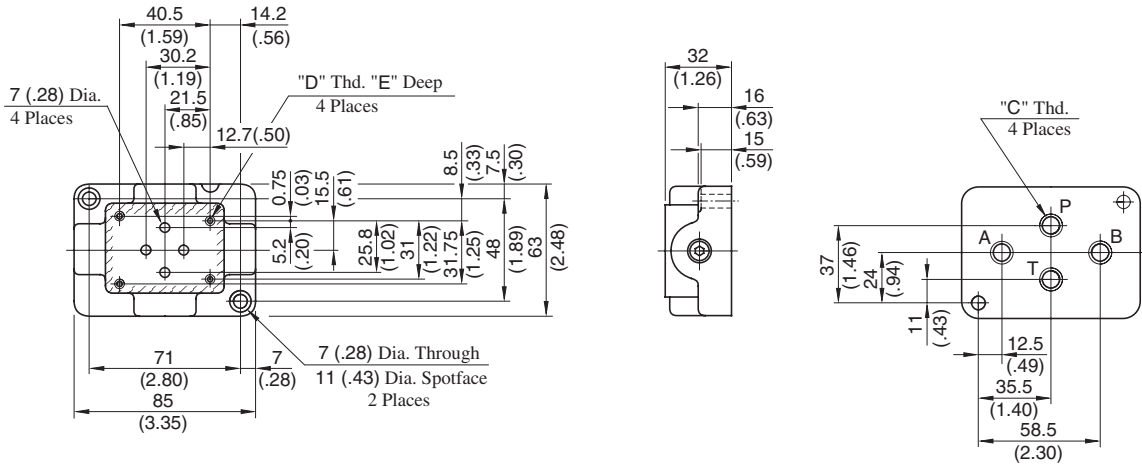

Sub-plate Model Numbers	Piping Size "C" Thd.	"D" Thd.	"E" mm(IN.)
DSGM-01-31	Rc 1/8	M5	10 (.39)
DSGM-01-3180	1/8 BSP.F		
DSGM-01-3190	1/8 NPT	No.10-24 UNC	12 (.47)
DSGM-01X-31	Rc 1/4	M5	10 (.39)
DSGM-01X-3180	1/4 BSP.F		
DSGM-01X-3190	1/4 NPT	No.10-24 UNC	12 (.47)
DSGM-01Y-31	Rc 3/8	M5	10 (.39)
DSGM-01Y-3190	3/8 NPT	No. 10-24 UNC	12 (.47)

## PLUG-IN CONNECTOR TYPE (N) PLUG-IN CONNECTOR WITH INDICATOR LIGHT (N1)

- Models with AC Solenoids: DSG-01-\*\*\*-A\*-N<sub>1</sub>-70/7090
- Models with DC Solenoids: (S-)DSG-01-\*\*\*-D\*-N<sub>1</sub>-70/7090
- Models with R Solenoids: (S-)DSG-01-\*\*\*-R\*-N-70/7090

DIMENSIONS IN  
MILLIMETRES (INCHES)

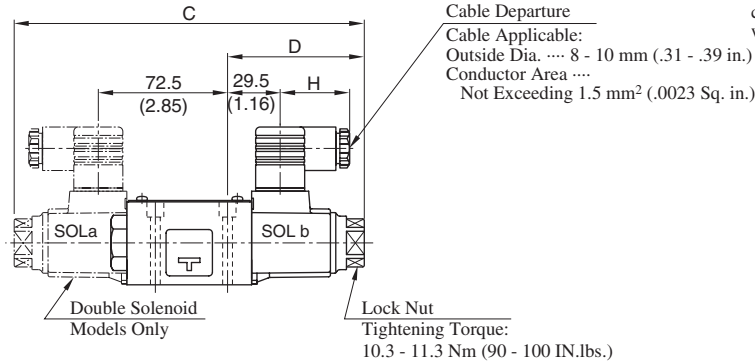

The position of the Plug-in connector can be changed as illustrated below by loosening the lock nut. After completion of the change, be sure to tighten the lock nut with the torque as specified below.

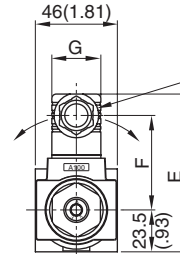

Model Numbers	C	D	E	F	G	H
DSG-01-***-A*-N*	196.4 (7.73)	76.7 (3.02)	88.5 (3.48)	53 (2.09)	27.5 (1.08)	39 (1.54)
(S-)DSG-01-***-D*-N*	204.4 (8.05)	80.7 (3.18)	99.5 (3.92)	64 (2.52)	27.5 (1.08)	39 (1.54)
(S-)DSG-01-***-R*-N	204.4 (8.05)	80.7 (3.18)	102.5 (4.04)	57.2 (2.25)	34 (1.34)	53 (2.09)

● For other dimensions, refer to "Terminal Box type" (Page 356).

## Models with Push Button & Lock Nut (S-)DSG-01-\*\*\*-\*-C

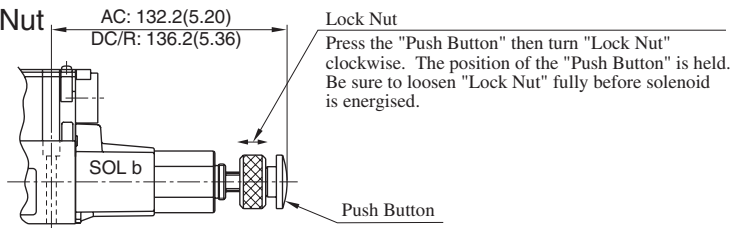

## Interchangeability in Installation Current and New Design

In order to achieve higher pressure, higher flow, lower pressure drop DSG-01 valves has been upgraded from the 60 design series to the 70 design series.

The figures in the table below are the comparison between the current and the new design valves.

### Specifications

Design Number	Max. Flow L/min (U.S.GPM)	Max. Operating Pressure MPa (PSI)	Max. T-Line Back Pres. MPa (PSI)	Max. Changeover Frequency Cycle/min (min <sup>-1</sup> )	Pressure Drop* MPa (PSI) {P→A}	Mass kg (lbs.)	
						3C*/2D*	2B*
New Design: 70	100(26.4)	35(5080)	21(3050)	300 (R Type sol. Only 120)	0.9(130) 1.0(145)	1.85(4.08)	1.4(3.09)
Current Design: 60	63(16.6)	31.5(4570)	16(2320)			2.2(4.85)	1.6(3.53)

\* Flow Rate: 60 L/min (15.9 U.S.GPM), Viscosity: 30 mm<sup>2</sup>/s (141 SSU), Spool type "2" (Closed centre)

### Interchangeability in Installation

Interchangeability in installation is maintained though there are minor differences in dimension as in the following table.

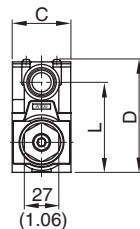
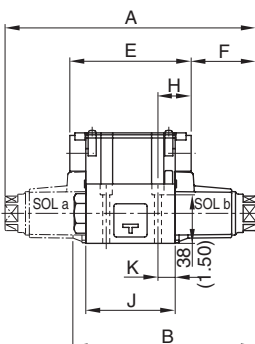

Coil Type	Design Number	A	B	C	D	E	F	H	J	K	L
AC	New Design : 70	196.4 (7.73)	142.2 (5.60)	46 (1.81)	88.8 (3.50)	95 (3.74)	50.7 (2.00)	26 (1.02)	70 (2.76)	13.5 (.53)	70.5 (2.78)
	Current Design : 60	191.4 (7.54)	142.7 (5.62)	48 (1.89)	90.3 (3.56)	90 (3.54)	50.7 (2.00)	23.5 (.93)	65 (2.56)	11 (.43)	72 (2.83)
DC R	New Design : 70	204.4 (8.05)	146.2 (5.76)	46 (1.81)	88.8 (3.50)	95 (3.74)	54.7 (2.15)	26 (1.02)	70 (2.76)	13.5 (.53)	70.5 (2.78)
	Current Design : 60	210 (8.27)	152 (5.98)	48 (1.89)	90.3 (3.56)	90 (3.54)	60 (2.36)	23.5 (.93)	65 (2.56)	11 (.43)	72 (2.83)

■ Details of Receptacle

Type of Electrical Conduit Connection	Double Solenoid Type	Single Solenoid Type
Terminal Box Type		
Plug-in Connector Type		

- ★1. There are two grounding terminals. You can use either one.
- ★2. If you do not need the common plate, remove it.
- ★3. With DC solenoids, polarity is no question.

**⚠ DANGER**

- Do not perform wiring while the power is on. Doing so may result in electric shock, burns or death.
- Make the wiring properly. Improper wiring will cause an irregular movement of the machine, resulting in a grave accident.

■ Electrical Circuit

Type of Electrical Conduit Connection	Electric Source		
	AC	DC	AC→DC Rectified
Terminal Box Type			
Plug-in Connector Type			

## List of Seals

\*-DSG-01-\*\*\*-\*-70/7090

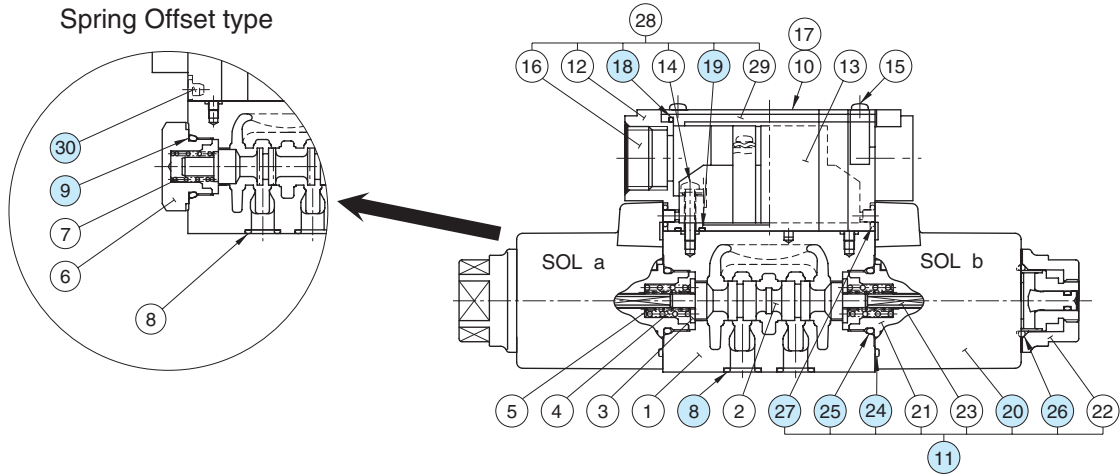

\*-DSG-01-\*\*\*-\*-N/N1-70/7090

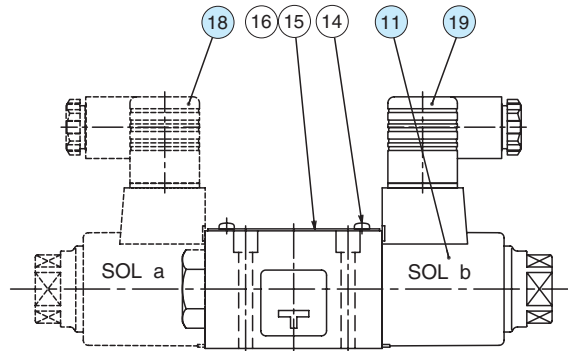

## List of Seals

Item	Name of Parts	Part Numbers	Qty.			Remarks
			3C*	2D*	2B*	
8	O-Ring	SO-NB-A-012 (NBR, Hs90)	4	4	4	
9	O-Ring	SO-NB-P18	—	—	1	
18	Packing	1790S-VK421290-8	1	1	1	
19	O-Ring	S6	2	2	2	
24	O-Ring	AS 568-026 (NBR, Hs70)	2	2	1	} Included in Solenoid Ass'y (Item 11)
25	O-Ring	SO-NB-P18	2	2	1	
26	O-Ring	SO-NA-P20	2	2	1	
27	O-Ring	SO-NA-P4	4	4	2	
30	Plug	1790S-VK418329-9	—	—	2	

★ When ordering the O-Rings, please specify the seal kit number from the table below.

Valve Model Numbers	Seal Kit No.	O-Ring Details for Seal Kit
*-DSG-01-***-*-70/7090	KS-DSG-01-70	(8)(4 Pcs.), (9) & (25) (2 Pcs., see above), (27) (4 Pcs.)
*-DSG-01-***-*-N-70/7090	KS-DSG-01-N-70	(8)(4 Pcs.), (9) & (25) (2 Pcs., see above)

● Solenoid Ass'y, Coil, Receptacle and Connector Refer to [page 360](#) for the details of these parts.

**E**  
 DSG-01 Series Solenoid Operated Directional Valves



■ Solenoid Ass'y, Coil, Receptacle and Connector Ass'y No.

Valve Model Numbers	⑪ Solenoid Ass'y No.	⑫ Coil No.	⑬ Receptacle Part No.	⑱ Connector Ass'y Part No.	⑲ Connector Ass'y Part No.	Remarks	
DSG-01-***-A100-70*	SA1-100-70	C-SA1-100-70	R1-70	—	—	Terminal Box Type	
DSG-01-***-A120-70*	SA1-120-70	C-SA1-120-70					
DSG-01-***-A200-70*	SA1-200-70	C-SA1-200-70					
DSG-01-***-A240-70*	SA1-240-70	C-SA1-240-70					
DSG-01-***-D12-70*	SD1-12-70	C-SD1-12-70	KR1-A-70				
DSG-01-***-D24-70*	SD1-24-70	C-SD1-24-70	KR1-B-70				
DSG-01-***-D48-70*	SD1-48-70	C-SD1-48-70	RR1-70				
DSG-01-***-R100-70*	SR1-100-70	C-SR1-100-70	KR1-A-70				
DSG-01-***-R200-70*	SR1-200-70	C-SR1-200-70					
S-DSG-01-***-D12-70*	SD1-12-S-70	C-SD1-12-70	KR1-B-70				
S-DSG-01-***-D24-70*	SD1-24-S-70	C-SD1-24-70	RR1-70				
S-DSG-01-***-D48-70*	SD1-48-S-70	C-SD1-48-70					
S-DSG-01-***-R100-70*	SR1-100-S-70	C-SR1-100-70	RR1-70				
S-DSG-01-***-R200-70*	SR1-200-S-70	C-SR1-200-70					
DSG-01-***-A100-N-70*	SA1-100-N-70	C-SA1-100-N-70	—				GDM-211-A-11
DSG-01-***-A120-N-70*	SA1-120-N-70	C-SA1-120-N-70					
DSG-01-***-A200-N-70*	SA1-200-N-70	C-SA1-200-N-70					
DSG-01-***-A240-N-70*	SA1-240-N-70	C-SA1-240-N-70					
DSG-01-***-D12-N-70*	SD1-12-N-70	C-SD1-12-N-70					
DSG-01-***-D24-N-70*	SD1-24-N-70	C-SD1-24-N-70					
DSG-01-***-D48-N-70*	SD1-48-N-70	C-SD1-48-N-70		GDME-211-R-A-10	GDME-211-R-B-10		
DSG-01-***-R100-N-70*	SR1-100-N-70	C-SR1-100-N-70					
DSG-01-***-R200-N-70*	SR1-200-N-70	C-SR1-200-N-70		GDM-211-A-11	GDM-211-B-11		
S-DSG-01-***-D12-N-70*	SD1-12-S-N-70	C-SD1-12-N-70					
S-DSG-01-***-D24-N-70*	SD1-24-S-N-70	C-SD1-24-N-70		GDME-211-R-A-10	GDME-211-R-B-10		
S-DSG-01-***-D48-N-70*	SD1-48-S-N-70	C-SD1-48-N-70					
S-DSG-01-***-R100-N-70*	SR1-100-S-N-70	C-SR1-100-N-70		SR1-200-S-N-70	GDML-211-1-11	GDML-211-1-11	
S-DSG-01-***-R200-N-70*	SR1-200-S-N-70	C-SR1-200-N-70					
DSG-01-***-A100-N1-70*	SA1-100-N-70	C-SA1-100-N-70		—	GDML-211-2-11	GDML-211-2-11	
DSG-01-***-A120-N1-70*	SA1-120-N-70	C-SA1-120-N-70					
DSG-01-***-A200-N1-70*	SA1-200-N-70	C-SA1-200-N-70					
DSG-01-***-A240-N1-70*	SA1-240-N-70	C-SA1-240-N-70			GDML-211-3-11	GDML-211-3-11	
DSG-01-***-D12-N1-70*	SD1-12-N-70	C-SD1-12-N-70					
DSG-01-***-D24-N1-70*	SD1-24-N-70	C-SD1-24-N-70	GDML-211-1-11		GDML-211-1-11		
DSG-01-***-D48-N1-70*	SD1-48-N-70	C-SD1-48-N-70					
S-DSG-01-***-D12-N1-70*	SD1-12-S-N-70	C-SD1-12-N-70	GDML-211-2-11		GDML-211-2-11		
S-DSG-01-***-D24-N1-70*	SD1-24-S-N-70	C-SD1-24-N-70					
S-DSG-01-***-D48-N1-70*	SD1-48-S-N-70	C-SD1-48-N-70	GDML-211-3-11		GDML-211-3-11		
S-DSG-01-***-D12-N1-70*	SD1-12-S-N-70	C-SD1-12-N-70					
S-DSG-01-***-D24-N1-70*	SD1-24-S-N-70	C-SD1-24-N-70	GDML-211-1-11		GDML-211-1-11		
S-DSG-01-***-D48-N1-70*	SD1-48-S-N-70	C-SD1-48-N-70					

Note: The connector assembly is not included in the solenoid assembly.